

Instruction Manual

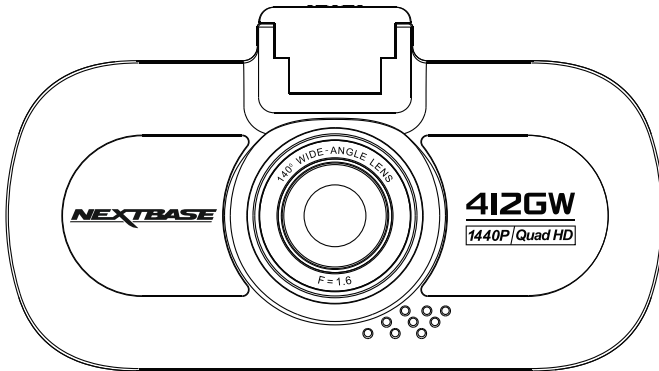

INTRODUCTION TO USING AN IN-CAR CAM

The iN-CAR CAM range of dash cams have been designed specifically with ease of use in mind, it is recommended NOT to change the default settings, which have been carefully selected to give the best performance for day to day use.

Basic operation.

The iN-CAR CAM is set to record video, in files of just 3 minutes in length. This means that each video file is a manageable size should you need to download and send to your insurance company. Eventually your MicroSD card will fill up with video files but don't worry, the camera automatically deletes the oldest file to make space for new recordings. This way you never run out of space and have plenty of driving historical evidence saved.

Please check the firmware version of the Dash Cam, the version can be found in the set up menu under System Info.

The latest versions are available to download from our website, where you can download and update when necessary.

Typically a 16Gb card will store the last 60 minutes of driving footage.

The Time and Date are automatically set upon the camera from satellite data, however it will always set Greenwich Mean Time (GMT). For summer months where the clocks are brought forward or for driving in other countries, adjust the time in the General Settings Menu (Timezone / DST) to account for the time difference from GMT by adding or subtracting 1 hour etc, if required.

There are 3 modes of camera operation - Video, Photo and Playback.

Video Mode: The default mode when the camera is turned on, for video recording.

Photo Mode: Allows you to take still photographs.

Playback mode: Allows you to view recorded video or photographs upon the dash cam LCD screen.

Press the MODE button on the iN-CAR CAM to select required mode.

Automatic Start / Stop Technology. The iN-CAR CAM senses power supplied to the cigarette lighter socket as soon as the vehicle ignition is turned on and will start to record automatically. When the ignition is turned off, the iN-CAR CAM will perform an automatic shutdown process.

INTRODUCTION TO USING AN IN-CAR CAM

1. Tips for capturing best video footage:

- 1.1 Position the iN-CAR CAM in the centre of the windscreen and ideally behind the rear view mirror so it is not a distraction to the driver.
- 1.2 Reduce the amount of sky in the picture, by angling the view of the camera towards the road. Too much sky will make the road appear darker due to the automatic exposure compensation.
- 1.3 Remove unnecessary items from your dashboard. If objects are placed on your dashboard these can cause reflections to be seen on the windscreen and these reflections may be captured during recording.
- 1.4 To improve dash board glare, a Nextbase Reflection free lens can be purchased.

2. Tips for stable memory card performance:

- 2.1 Periodically reformat the memory card. Every 2-3 weeks we recommend that you reformat the memory card. This will wipe any files from the card and set it up afresh for continued use with your iN-CAR CAM.
Of course, you should only do this AFTER you've downloaded any files from the card that you may want to keep, as formatting the card will remove all content.
- 2.1 Format your memory card using the iN-CAR CAM. This will make sure that the card is structured specifically for your camera. Press MENU twice and choose the Format Card option. Follow the on-screen instructions accordingly.
- 2.2 Switch off the iN-CAR CAM before removing the SD memory card, to prevent the chance of damage being caused to the memory card or the files stored upon it, turn OFF the iN-CAR CAM before removing or inserting the memory card.

TABLE OF CONTENTS

INTRODUCTION TO USING AN IN-CAR CAM	02
TABLE OF CONTENTS	04
PRECAUTIONS	05
CAUTIONS ON USING THIS PRODUCT	05
FCC STATEMENT	06
PRODUCT SPECIFICATION	09
PACKAGE CONTENTS	10
PRODUCT FEATURES	10
POWERED GPS MOUNT	11
CAMERA - PARTS & CONTROLS	12
IN VEHICLE INSTALLATION	17
FIRST TIME USE	21
VIDEO MODE	22
PHOTO MODE	27
PLAYBACK MODE	29
SETUP MENU	33
PC CONNECTION	36
TV CONNECTION	37
Wi-Fi CONNECTION	37
TROUBLE SHOOTING	38

PRECAUTIONS

Please read this manual carefully before operation and keep it for future reference. It will be helpful should you encounter any operational problem.

WARNING: Do not expose this product to rain, moisture or water under any circumstances, doing so may result in the risk of electric shock or fire.

CAUTION: To reduce the risk of electric shock, do not perform any servicing other than that contained in the instruction manual unless you are qualified to do so.

Have the unit serviced by a qualified service technician if;

The Unit has been exposed to rain or water.

The unit does not seem to operate normally.

The unit exhibits a marked change in performance.

CHOKING HAZARD: Some Products may contain components that are small enough to be swallowed.

Please keep out of reach of children.

LCD: A Liquid Crystal Display (LCD) screen is a multilayer complex component, containing 691,200 pixels. Pixels can however fail during normal product life. 1 pixel = 0.0001% failure rate, and one pixel failure per year of operation is considered normal and not a cause for concern.

WEEE: Disposal of Waste Electrical and Electronic Equipment and/or Battery by users in private households in the European Union.



This symbol on the product or on the packaging indicates that this cannot be disposed of as household waste. You must dispose of your waste equipment and/or battery by handing it over to the applicable take-back scheme for the recycling of electronic equipment and/or batteries. For more information please contact your local household waste disposal office.

CAUTIONS ON USING THIS PRODUCT

1. Ensure that the windscreen is free of dirt or grease before placing mount upon it.
2. Do not obscure the view of the road ahead or impede the deployment of any airbags in the event of an accident.
3. When not in use, please disconnect the car adaptor from both the 12/24Vdc outlet in your vehicle and the device itself.
4. Only clean the device with a soft dry cloth, for tough dirt, apply some neutral detergent diluted in 5 to 6 parts water to a soft cloth.
Note that alcohol, thinner, benzene etc could cause damage to the paint or coatings.
5. Avoid making contact with the lenses as damage may be caused.
6. If required clean the glass lens carefully using spectacle lens cleaning fluid on a soft cloth only.
7. The video recordings made by this Digital Video Recorder are intended for personal use only.
8. Publication of the recordings on Youtube, the internet or other methods are subject to the Data Protection Act and the requirements thereof must be adhered to.
If the Digital Video Recorder is to be used within a commercial environment, i.e. truck use, then the CCTV regulation apply also, in addition to the Data Protection Act regulations. This includes labelling to identify the use of CCTV is taking place, the omission of Audio recording and informing the relevant authorities of who controls the data.
9. Video playback upon the device which is visible to the driver is prohibited or restricted in some countries or States. Please adhere to these laws.
10. Whilst driving, do not adjust the controls of your device as this is a distraction to driving.

FCC STATEMENT

This device complies with Part 15 of the FCC Rules. Operation is subject to the following two conditions: (1) this device may not cause harmful interference, and (2) this device must accept any interference received, including interference that may cause undesired operation.

This equipment has been tested and found to comply with the limits for a Class B digital device, pursuant to Part 15 of the FCC Rules. These limits are designed to provide reasonable protection against harmful interference in a residential installation. This equipment generates, uses and can radiate radio frequency energy and, if not installed and used in accordance with the instructions, may cause harmful interference to radio communications. However, there is no guarantee that interference will not occur in a particular installation. If this equipment does cause harmful interference to radio or television reception, which can be determined by turning the equipment off and on, the user is encouraged to try to correct the interference by one or more of the following measures:

- Reorient or relocate the receiving antenna.
- Increase the separation between the equipment and receiver.
- Connect the equipment to an outlet on a circuit different from that to which the receiver is connected.
- Consult the dealer or an experienced radio/TV technician for help.
- This appliance and its antenna must not be co-located or operated conjunction with any other antenna or transmitter.
- A minimum separation distance of 20cm must be maintained between the antenna and the person for this appliance to satisfy the RF exposure requirements.

FCC CAUTION:

Any changes or modifications to the equipment not expressly approved by the party responsible for compliance could void your authority to operate the equipment.

SIMPLIFIED EU DECLARATION OF CONFORMITY

Hereby, Portable Multimedia Limited declares that the radio equipment type NBDVR412GW is in compliance with Directive 2014/53/EU. The full text of the EU declaration of conformity is available at the following internet address: <https://www.nextbase.com/certifications/>

PRODUCT WIRELESS INFORMATION

2400–2483.5 MHz: Wi-Fi (Max 16.3 dBm), BT (Max 6.0 dBm), BLE (Max 6.0 dBm).

RF EXPOSURE INFORMATION (MPE)

This device meets the EU requirements and the International Commission on Non-Ionising Radiation Protection (ICNIRP) on the limitation of exposure of the general public to electromagnetic fields by way of health protection. To comply with the RF exposure requirements, this equipment must be operated in a minimum of 20 cm separation distance to the user.

FCC - SUPPLIER'S DECLARATION OF CONFORMITY STATEMENT

SUPPLIER'S DECLARATION OF CONFORMITY

(47 CFR Section 2.906).

We; Tank Design

Hereby, Declare that the essential requirements set out in the 47 CFR Sections 2.906 of FCC, have been fully fulfilled on our product with indication below:

1. Applicant's Info

Company Name: Portable Multimedia Ltd

Mailing Address: Unit 2, Caerphilly Business Park, Van Road, Caerphilly. CF83 3ED. UK

Contact: Graham Lambert

Tel: +44 02920 866429

Email Address: support@nextbase.com

2. Product Info

Product Name: Dash Cam

Model No.: NBDVR412GW

Brand Name: Nextbase

3. Applied Standard

Standards

E-CFR Title 47 Part 15 Subpart B—Unintentional Radiators: 2017

Report No. WTS18S01100307E

4. Test Firm Used to Take Measurements:

Name: Waltek Services (Shenzhen) Co., Ltd.

Address: 1/F, Fukangtai Building, West Baima Rd Songgang Street, Baoan District,
Shenzhen, Guangdong, People's Republic of China, 518105

Contact Name: Philo Zhong

Tel: +86 755 8355 1033 802

Email: CB@waltek.com.cn

Designation No.: CN1201

FRN: 0027148261

FCC - SUPPLIER'S DECLARATION OF CONFORMITY STATEMENT

SUPPLIER'S DECLARATION OF CONFORMITY CONTINUED

5. FCC Marking



6. Responsibilities and obligations

Strictly follow the FCC rules of 2.906, 2.908, 2.909.

7. Applicant's Authorization

Company Name: Portable Multimedia Ltd

Mailing Address: Unit 2, Caerphilly Business Park, Van Road, Caerphilly. CF83 3ED. UK

Contact Person: Graham Lambert

Signature: *G. K. Lambert*

Email Address: support@nextbase.com

Tel: +44 02920 866429

Date: 28th March 2018

8. Responsible party in US.

Company name: Tank Design

Mailing Address: 158 Sidney Street, Cambridge, MA 02139, United States

Contact Person: Mr Scott Watts

Signature: *Scott Watts*

Email Address: SWatts@tankdesign.com

Tel: (617) 388-8380

Date: 28th March 2018

PRODUCT SPECIFICATION

Model Number / Name	NBDVR412GW / NEXTBASE iN-CAR CAM PROFESSIONAL
Power Requirements	5V / 1.5A
Power Supply	12-24Vdc Car Power Cable (supplied) Fuse Type: 20mm / 2A Output: 5Vdc
Sensor Resolution	4M Pixel (4,085,760 Pixel)
Lens - Type / Angle / Aperture	6G / 140° / F1.6
Recording Resolution	2560 x 1440 @ 30fps (default)
Screen Size	3.0"
Screen Resolution	960 (W) X 240 (H) pixels x RGB
Screen Ratio	16:9
Card Reader	MicroSD, Class 10, up to 128GB
SD Card (Recommended Type)	8-128GB MicroSD Card, Class 10 (48mb/s), for best results use a recognized brand
SD Card Recorded File Capacity (based on default settings)	8GB MicroSD = 30 minutes of recording 16GB MicroSD = 60 minutes of recording 32GB MicroSD = 120 minutes of recording 64GB MicroSD = 240 minutes of recording 128GB MicroSD = 480 minutes of recording
Recording Format	MOV
Video / Audio Out	High Definition: Type C Socket (Video / Audio) Standard Definition: 3.5mm Jack (Video / Audio)
Internal Battery	Lithium-ion 3.7V / 260mAh (approx. 30mins recording time) Battery design allows the 'Auto Power Off' feature to function in event of power loss within the vehicle. It is not intended as an alternative power source to replace the supplied car adaptor.
Unit Dimensions	106 x 59 x 38mm
Unit Weight	86g

Android is a trademark of Google Inc. in the United States and other countries.

Mac is a registered trademarks of Apple Inc. in the United States and other countries.

iOS is a trademark or registered trademark of Cisco in the United States and other countries.

© 2015 Google Inc. All rights reserved. Google Maps™ mapping service is a trademark of Google Inc.

Windows is a registered trademark of Microsoft Corporation in the United States and other countries.

Exmor R is a trademark of Sony Corporation.

STARVIS is a trademark of Sony Corporation.





microSD™ and the microSD logo are trademarks of SD-3C, LLC.

Wi-Fi® is a registered mark of Wi-Fi Alliance Corporation.

Other trademarks and trade names are those of their respective owners.

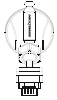
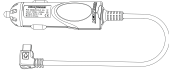
PACKAGE CONTENTS

Please check the contents of your iN-CAR CAM product.

<p>iN-CAR CAM</p> 	<p>Powered GPS Mount</p>  <p>(adhesive mount included)</p>	<p>Car Power Cable</p> 	<p>USB Cable</p> 
<p>Window Sticker</p> 	<p>Quick Start Guide</p> 		

Product appearance may differ slightly to that shown above.

PRODUCT FEATURES

Thank you for purchasing this NEXTBASE iN-CAR CAM product, in this section we will outline some of the features available with this dash cam.

3.0" LCD Colour Screen

LCD screen for ease of use and viewing the playback of recorded videos and photos.

Powered GPS Mount

Supplied with an Easy-Fit powered mount, which allows the iN-CAR CAM to be fitted and removed quickly and easily. The car power cable can remain in place, connected to the mount.

GPS Logger

GPS co-ordinates, date and time are recorded, the journey can then be viewed using the supplied Windows & Mac playback software.

The software is also available to download from www.nextbase.com

WiFi Connectivity

Connect your smartphone or tablet device to the iN-CAR CAM, can be used to Start/Stop recording or to view or download files from the iN-CAR CAM

G Sensor / File Protection

In the event of an impact the device will automatically 'protect' the recording, stopping the file from being over-written. This can also be performed manually, by pressing the 'protect' button.

Individual files can also be 'protected' when viewed within playback mode.

Automatic Start / Stop Technology

The iN-CAR CAM senses power supplied to the cigarette lighter socket, as soon as the vehicle ignition is turned on and will start to record automatically.

When the ignition is turned off, the iN-CAR CAM will perform an automatic shutdown process.

Parking Mode

The iN-CAR CAM turns on automatically to record 2 minutes of video, when physical movement of your vehicle is detected.

Built-in Microphone & Speaker

Record audio to compliment the video recordings.

POWERED GPS MOUNT

Please see below to identify the parts of the supplied powered mount.

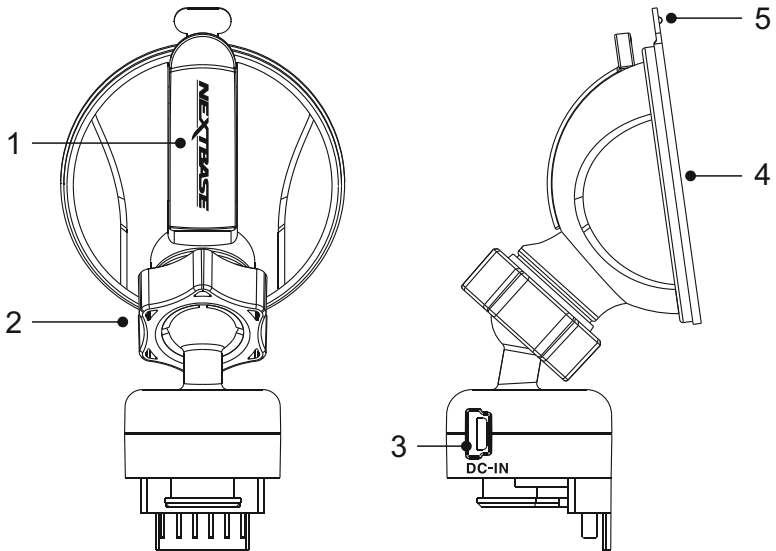

1. Locking lever

The locking lever is used to attach and release the window mount to your vehicles windscreen. Pull the lever down to prepare the window mount for use. Once the mount is firmly upon the windscreen (in a suitable location) push the lever to lock the mount in place.

2. Locking ring

Loosen the locking ring to adjust the iN-CAR CAM position if required, remembering to re-tighten before use.

3. DC-IN socket

Connect the supplied car power cable here.

4. Suction cup

This is used to attach and release the window mount to your vehicles windscreen. Affix to a clear piece of windscreen where there is no paint effect applied.

5. Suction release tab

Once the locking lever has been opened use this release tab to break the seal between the mount and windscreen.

CAMERA - PARTS & CONTROLS

Please see below to identify the parts and controls of your iN-CAR CAM.

Front:

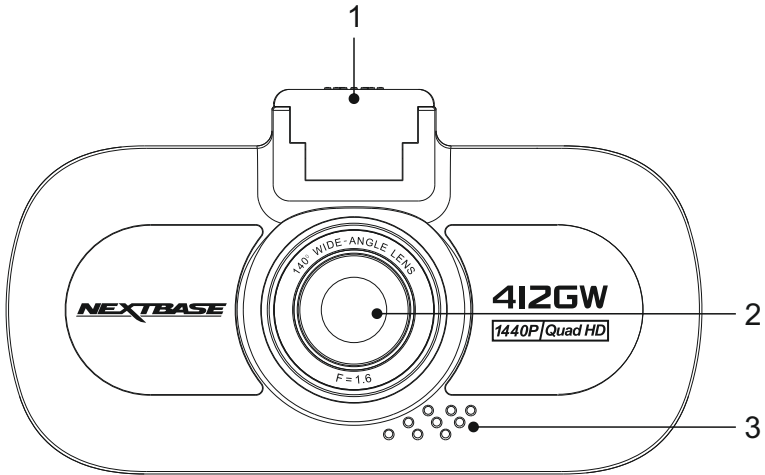

- 1. Mounting point (located under dust cover)**
After removing the dust cover, attach the supplied powered GPS mount here.
- 2. Camera lens**
Wide Angle 140°, 6 Element glass lens for optimum picture quality.
- 3. Speaker**
Integral speaker for audio playback directly from the iN-CAR CAM.

CAMERA - PARTS & CONTROLS (CONTD.)

Back:

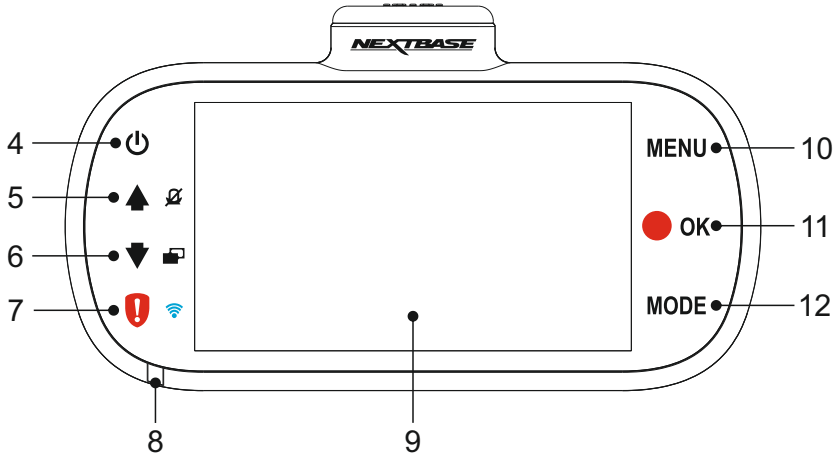

4. Power On / Off

Press and hold for 2 seconds to turn on / off the iN-CAR CAM.

5. Up / Microphone Off

Up:

Press to navigate up within menus and to move to the previous file when in playback mode.

Microphone Off:

Press to turn off / on the microphone (audio recording), only available whilst in video mode.

6. Down / Screen Off

Down:

Press to navigate down within menus and to move to the next file when in playback mode.

Screen Off:

Press to turn off / on the screen, only available whilst in video mode.

7. Protect File / WiFi

Protect File:

Press whilst recording to protect the current file in event of an emergency situation.

Note:

- A marker will be seen on the recorded file noting when the protection took place.

WiFi:

Press and hold for three seconds to turn on WiFi mode, this is not available whilst recording or during playback.

Note:

- To exit WiFi mode please press the OK button once paired device has been disconnected.

CAMERA - PARTS & CONTROLS (CONTD.)

Continued from previous page.

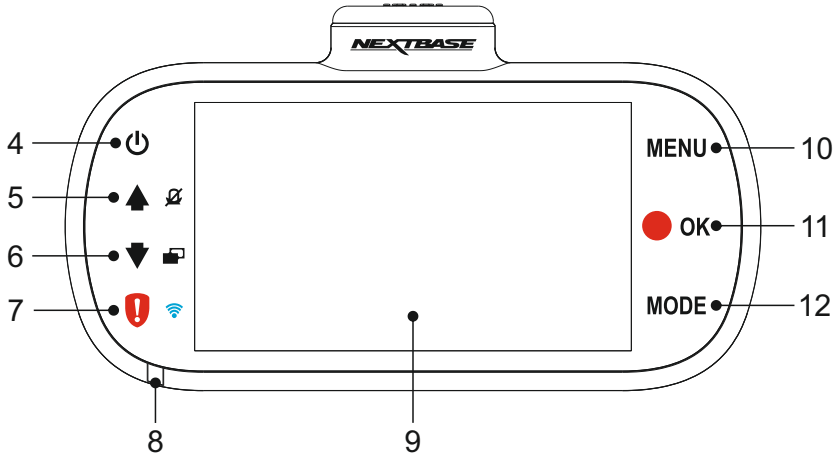

8. Dual colour LED indicator

Red = power on
Red flashing = recording
Blue = battery charging

9. Screen

3.0" LCD colour screen for the viewing of recorded files on the iN-CAR CAM.

10. Menu

Press to open the menu within current mode, press twice to open the Setup menu.

11. Record / OK

Record:

Press to start or stop a recording when in video mode, or take a photo when in photo mode.

OK:

Press to confirm selection when in menus.

12. Mode

Press to change between video, photo or playback modes.

CAMERA - PARTS & CONTROLS (CONTD.)

Top:

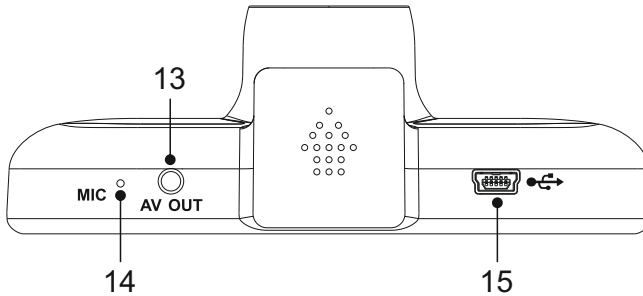

13. AV Out socket

Used to connect your iN-CAR CAM to a television using an AV Cable (sold separately).

14. Microphone

Integral microphone for audio recording.

15. DC-IN & USB socket

Connect the supplied car power cable or USB data cable here.

Note:

- Normally the car power cable is connected to the mount when in use, not directly to this socket.

Bottom:

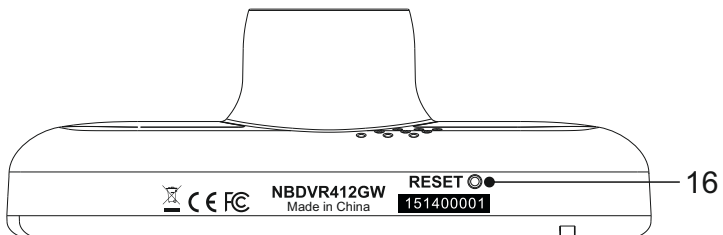

16. Reset button

In the unlikely event the iN-CAR CAM becomes unresponsive, press the RESET button to restart the iN-CAR CAM.

CAMERA - PARTS & CONTROLS (CONTD.)

Sides:

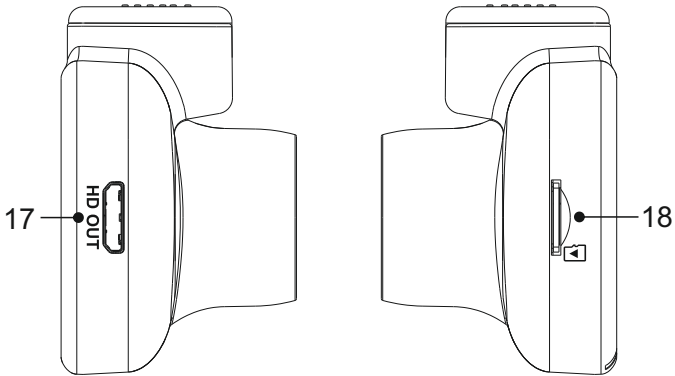

17. HD Output

Used to connect your iN-CAR CAM to a television using an HD Cable (sold separately).

18. MicroSD Card slot

Insert the MicroSD card here, taking care that the gold contacts are facing towards the back of the iN-CAR CAM.

IN VEHICLE INSTALLATION

Please follow the instructions below for first-time installation of the iN-CAR CAM. For day to day use simply remove the camera from the mount as required.

1. Insert MicroSD Card

Insert a suitable MicroSD card (Class 10 48/Mbps) in to the iN-CAR CAM, taking care that the gold contacts are facing towards the LCD screen side of the iN-CAR CAM. Push the memory card until it clicks into place.

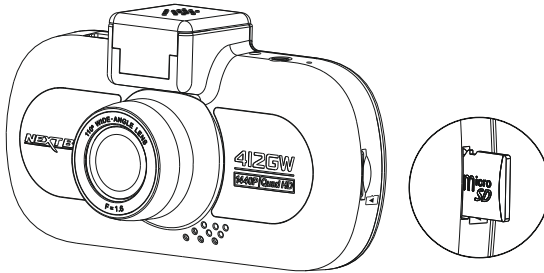

Note:

- Use the edge of a small coin (or similar object) to push the memory card in place if required. Take care that card has 'clicked' into place, a second push inwards will release the memory card.
- Do not remove or insert the memory card when the iN-CAR CAM is turned on. This may damage the memory card.

2. Remove dust cover from iN-CAR CAM

Remove the dust cover that is located on the top of the iN-CAR CAM to gain access to the mounting point.

To remove the dust cover, slide it forwards away from the LCD screen of the iN-CAR CAM.

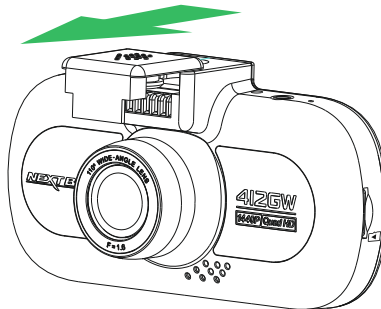

Note:

- If the iN-CAR CAM is not to be used for a period of time please replace the dust cover to help keep the metal contacts free of dust or other contaminants.

IN VEHICLE INSTALLATION (CONTD.)

3. Attach the mount to the iN-CAR CAM

Slide the iN-CAR CAM onto the mount. Once attached magnets within the mount will hold the two parts together.

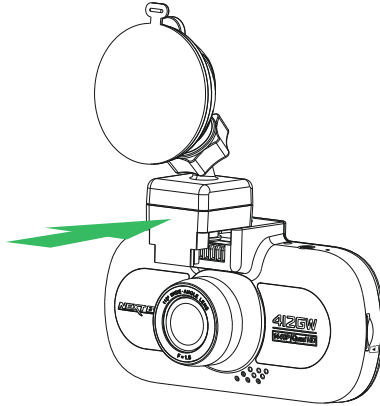

4. Attach the mount to the windscreen

Remove the protective plastic film from the suction cup of the mount.

Select a suitable position for the mount and clean the windscreen with a dry / clean cloth to achieve a good contact between the glass and suction cup.

Release the locking lever of the mount by pulling down and then whilst holding the suction cup onto the glass push the lever up to secure the mount to the windscreen.

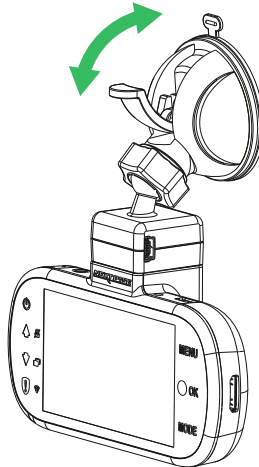

To use the supplied adhesive mount, simply unscrew the locking ring and pull the mount apart. Replace the sucker mount, remembering to tighten the locking ring securely.

Note:

- Choose a smooth glass area without painted effect.
- Please ensure that once mounted the iN-CAR CAM will be located within the area of the vehicles windscreen wipers to maintain a clear view during rainfall.

IN VEHICLE INSTALLATION (CONTD.)

5. Connect car power cable

Connect the supplied car power cable to DC-IN socket of the mount.

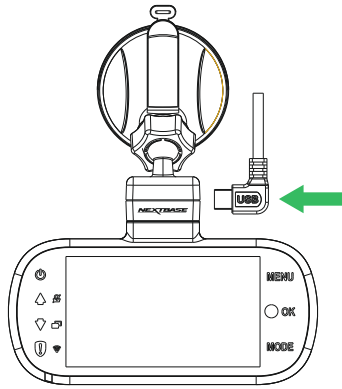

Plug the power cable into the 12-24Vdc outlet of your vehicle.

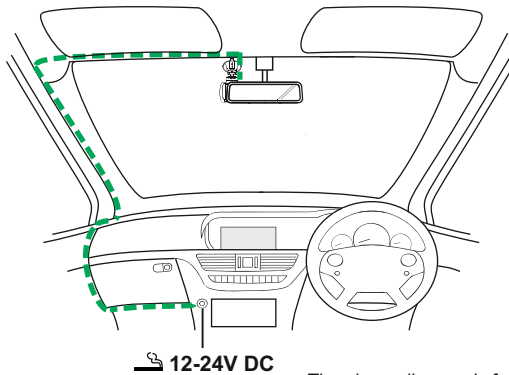

The above diagram is for illustration purposes only.

The iN-CAR CAM will automatically power on and start recording once power is available. In some vehicles this will be when connections are made, for others the iN-CAR CAM will power on once the ignition has been turned on.

Should your vehicle not have a 12-24Vdc outlet, but does have a 5Vdc USB Outlet, this can be used instead. Connect the USB cable supplied with your iN-CAR CAM in place of the car power cable. Ensure you connect the USB cable to the Powered Mount only, NOT directly to the camera when using in-car

Note:

- Do NOT wire the iN-CAR CAM directly to a 12V supply by cutting the cigarette plug off the end of the cable, or damage will result.
- A Nextbase hardwire kit is available from your retailer. This connects directly to the vehicle fusebox and hence leaves your cigarette socket available for Phone / Sat Nav charging. The Nextbase hardwire kit includes the necessary 12-24VDC to 5Vdc convertor and battery protection circuitry.

IN VEHICLE INSTALLATION (CONTD.)

Please read and follow the notes below for the safe operation of your iN-CAR CAM within your vehicle.

As per the installation instructions, you must install the iN-CAR CAM so it does NOT obstruct the drivers view of the road, preferably on the passenger side of the vehicle and behind the rear view mirror. Whilst the iN-CAR CAM clearly needs to view through the windscreen in an area swept by the windscreen wipers, the iN-CAR CAM should be installed so as not to intrude significantly within the wiped area. A 40mm intrusion into the green wiped area is the maximum permitted by law.

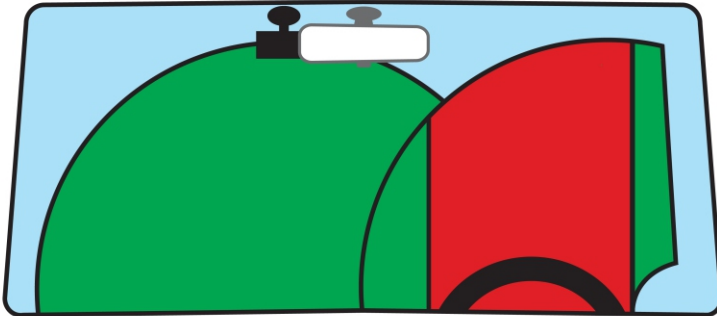

Do NOT mount the iN-CAR CAM in front of the driver, as depicted by the red area in the above illustration.

When installing the iN-CAR CAM in a vehicle, always place the device securely against the windscreen and where possible conceal the power cable under trim. Make sure that the iN-CAR CAM power cable does not interfere with the drivers operating controls, such as the steering wheel, pedals or gear levers.

Do NOT mount the iN-CAR CAM in front of an airbag field of deployment or in a position to obscure any mirrors.

Clean the windscreen at the point of location, prior to fitting the iN-CAR CAM, also, applying some moisture to the suction cup may be beneficial, to ensure absolute adhesion.

It is recommended NOT to operate the iN-CAR CAM whilst driving. The automatic Start-Stop technology incorporated within the device negates any need to operate the controls whilst driving.

Adjust any settings or review recordings whilst stationary, not whilst driving.

Only use your mobile device whilst stationary, not whilst driving.

After the preliminary SETUP has been carried out upon the iN-CAR CAM, adjust the Screen Saver setting to 1 minute, this will blank the screen automatically shortly after starting the vehicle and therefore the screen will NOT be a distraction in any way to the driver.

FIRST TIME USE

To ensure the set up of this Dash Cam is as quick and simple as possible, there is an easy to follow 'First Time Use' menu.

This menu is used to set your preferred Language, Country (this defines your time zone) and speed units.

The menu is available when -

- 1) The Dash Cam is first turned on.
- 2) There has been a Firmware update applied to the Dash Cam.
- 3) After the Dash Cams settings have been reset, by using the 'Defaults Settings' option within the Setup Menu.

Simply follow the on screen instructions to select the Language, Country and Speed Units. The settings that influence the displayed time & date will be applied upon receiving a GPS connection.

Note:

- Whilst the First Time Use menus adjust the settings within the Dash Cam, the settings can still be adjusted thereafter, by using the normal Setup Menu options. Changing country location is one such example of a change you could make, after the First Time Use setup.

VIDEO MODE

The key below explains the various information displayed on the screen when your iN-CAR CAM is in Video mode, some icons will only be displayed once the relevant function has been selected within the Video menu, as described below.

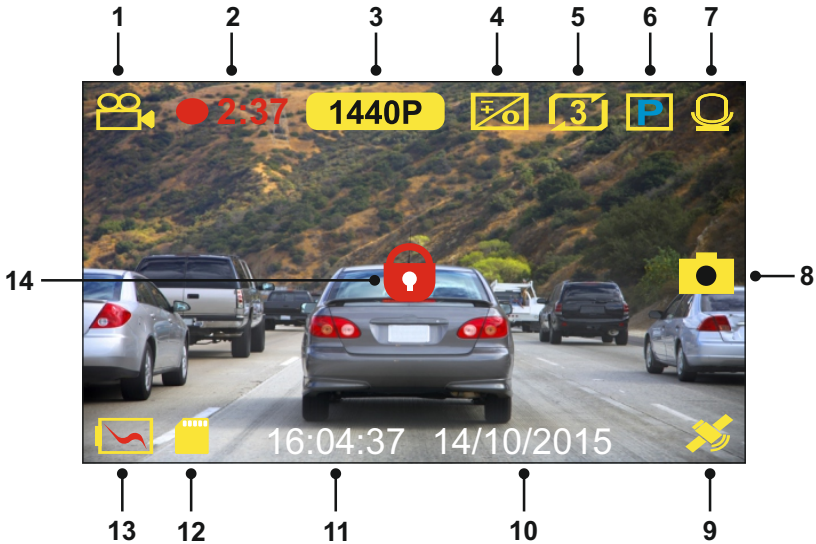

1. Mode: indicates the iN-CAR CAM is in Video mode.
2. Recording: appears on screen when recording is in progress.
3. Resolution: displays the current resolution.
4. Exposure: displays current Exposure level setting.
5. Video Length: displays the length of the individual recordings in minutes.
6. Parking Mode: appears on screen when Parking Mode has been turned on.
7. Microphone: displayed on screen when Audio Recording is active.
8. Screen Capture: appears on screen during screen capture.
9. GPS: The satellite icon will flash whilst the iN-CAR CAM locates satellites. Once a stable signal is received, the icon will stop flashing and remain on screen.
10. Date: current date.
11. Time: current time.
12. Memory Card: indicates whether a memory card is present.
13. Battery: indicates whether iN-CAR CAM is running on battery or external power.
14. Protected: shown on screen when a video file has been protected by activation of the G Sensor or by the pressing of the file protect button.

The default settings within the iN-CAR CAM have been set to allow you to use the iN-CAR CAM without the need to change any settings.

See the next page for video menu settings, should you want to make any adjustments however.

VIDEO MODE (CONTD.)

Video Menu

The Video Menu is accessed by pressing the MENU button whilst in video mode.

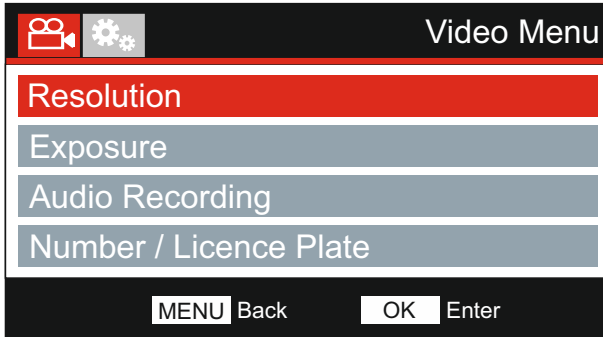

The default settings have been carefully selected to allow you to use the iN-CAR CAM without the need to change any settings. However, should you wish to change a setting then please see below.

Use the up and down buttons to highlight the function that you'd like to change and press the OK button to enter the settings sub-menu.

Once in the submenu, use the up and down buttons to highlight the required setting and then press OK to confirm your selection and return to the Video Menu.

Press the MENU button twice to return to video mode.

Note:

- Menus are not accessible whilst the iN-CAR CAM is recording.

1. Resolution

Select recording resolution, this will increase or decrease the quality of the recorded video.

Options: 1440P, 1080P 60FPS, 1080P and 720P

Default Setting: 1440P

Note:

- The 1080P 60FPS setting will remain at 30fps during night-time recording, due to the low level light conditions.

- The Low resolution file is always set to 800 x 480 @ 30FPS

2. Exposure

Adjust exposure level for different light conditions.

Options: +2, +1, 0, -1 and -2

Default Setting: 0

3. Audio Recording

Turn On / Off the microphone.

Options: On and Off

Default Setting: On

4. Number / Licence Plate

Enter the registration number for your vehicle, this will then be shown on the video file.

VIDEO MODE (CONTD.)

Continued from previous page.

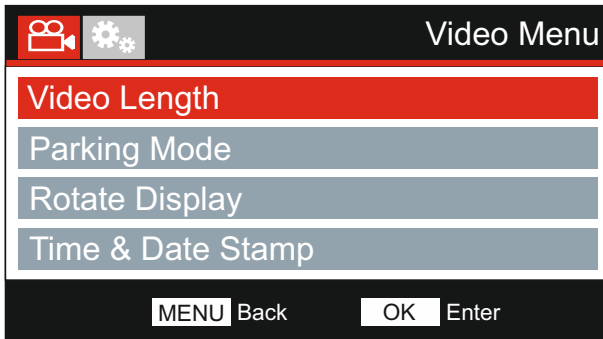

5. Video Length

Select the duration of the individual recorded video files. The iN-CAR CAM will continue recording, filling the memory card. When the memory card becomes full, the oldest file will be automatically deleted to make space for the new recording.

Note:

- Protected files will never be deleted.

Options: 2 Minutes, 3 Minutes and 5 Minutes

Default Setting: 3 Minutes

6. Parking Mode

When Parking Mode has been turned on, the iN-CAR CAM enters standby mode when the 12Vdc supply has been turned OFF (typically removing your ignition key).

The iN-CAR CAM will also enter standby mode if no physical movement is detected for 3 minutes, this is designed to allow use of a permanent 12Vdc supply, i.e hard-wire kit.

Should physical movement of the vehicle be detected, the iN-CAR CAM will power on and start recording a 2 minute protected video. If no further physical movement is detected then the iN-CAR CAM will return to standby mode, if physical movement is detected subsequently, then the camera will continue to record normally, i.e. driving once more.

Options: On and Off

Default Setting: Off

7. Rotate Display

Rotate the display 180°, particularly useful should the iN-CAR CAM be mounted on the dashboard, the iN-CAR CAM control button functions do not rotate.

8. Time & Date Stamp

Turn On / Off the time and date stamp shown on recorded files.

Options: Off and On

Default Setting: On

VIDEO MODE (CONTD.)

Continued from previous page.

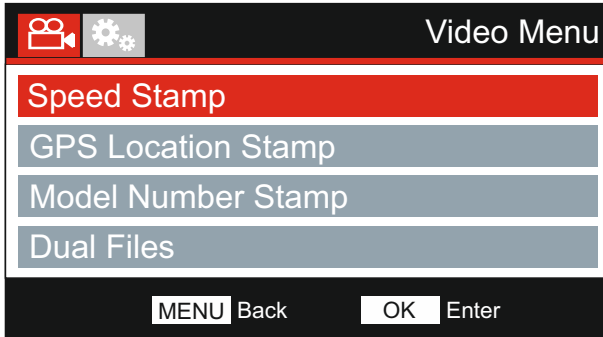

9. Speed Stamp

Turn On / Off the Speed Stamp shown on recorded files.

Options: On and Off

Default Setting: On

10. GPS Location Stamp

Turn On / Off both the GPS co-ordinates and speed stamp that are shown on recorded files. When a recording is viewed using the supplied NEXTBASE Replay playback software both the GPS co-ordinates and speed information remains available.

Options: On and Off

Default Setting: On

11. Model Number Stamp

Turn On / Off the Model Number stamp shown in the bottom left corner of recorded files.

Options: On and Off

Default Setting: On

VIDEO MODE (CONTD.)

Continued from previous page.

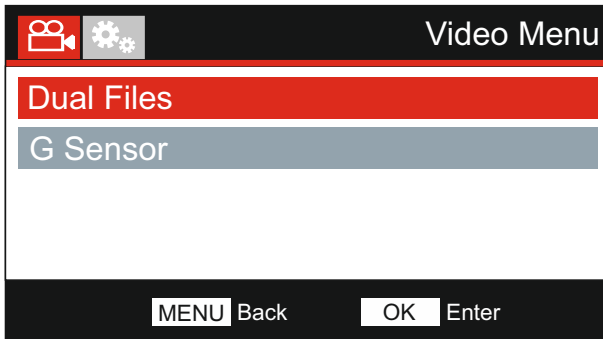

12. Dual Files

During normal recording there will be two files saved to the SD Card, one will be the full sized High Resolution recording (example: 2560 x 1440) and the other is a Low Resolution recording (848 x 480).

The Low resolution file can be turned On/Off with this setting.

The two recorded files can be identified by the filenames:
170419_102024_001_HI.MOV and 170419_102024_001_LO.MOV

Both files will be treated as a single recording by the Dash Cam, in regards file protection and deletion.

The Low Resolution recording is used when streaming recordings from the Dash Cam to the CAM Viewer™ APP, this reduces any buffering that may be seen if the full-sized High Resolution recording is used.

Note:

- Only the larger High Resolution recordings will have the Stamps, GPS Location, Speed etc.

Options: On and Off

Default Setting: On

13. G Sensor

Turn Off or adjust the sensitivity of the built in G Sensor. The G Sensor detects forces which will automatically protect the current recording in event of a collision.

Note:

- This does not affect Parking mode sensitivity.

Options: High, Medium, Low and Off

Default Setting: Medium

Note:

- Within the Setup Menu which is accessed by pressing the MENU button twice, there is a 'Default Settings' option to allow you to reset the iN-CAR CAM to the factory defaults, if required.

PHOTO MODE

Press the MODE button to select Photo mode.

The key below explains the information displayed on the screen when your iN-CAR CAM is in Photo mode.



1. Mode: indicates the iN-CAR CAM is in Photo mode.
2. Exposure: displays current exposure level setting.
3. Date: current date.
4. Time: current time.
5. Memory Card: indicates whether a memory card is present.
6. Battery: indicates whether iN-CAR CAM is running on battery or external power.

See the next page for photo menu settings.

PHOTO MODE (CONTD.)

Photo Menu

The Photo Menu is accessed by pressing the MENU button whilst in photo mode.

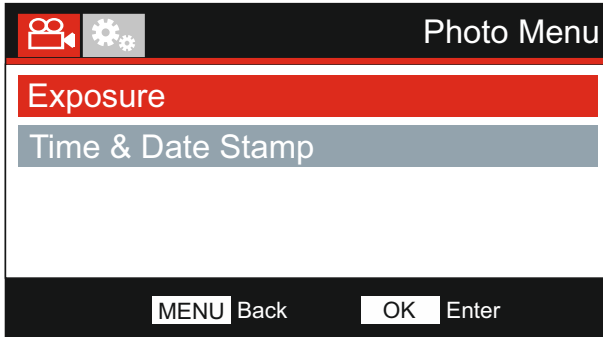

The default settings have been carefully selected to allow you to use the iN-CAR CAM without the need to change any settings. However, should you wish to change a setting then please see below.

Use the up and down buttons to highlight the function that you'd like to change and press the OK button to enter the settings sub-menu.

Once in the submenu, use the up and down buttons to highlight the required setting and then press OK to confirm your selection and return to the Photo Menu.

Press the MENU button twice to return to photo mode.

1. **Exposure**

Adjust exposure level for different light conditions.

Options: +2, +1, 0, -1 and -2

Default Setting: 0

2. **Time & Date Stamp**

Turn On / Off the time and date stamp shown on images.

Options: On and Off

Default Setting: On

Note:

- Within the Setup Menu which is accessed by pressing the MENU button twice, there is a 'Default Settings' option to allow you to reset the iN-CAR CAM to the factory defaults, if required.

PLAYBACK MODE

Press the MODE button to select Playback mode, the Dash Cam will display the last recorded file.

Dependent on the type of file, the on-screen information and playback functions differ.

Video Files:



1. Mode: indicates the Dash Cam is in Playback mode.
2. File type: indicates whether a video or photo file is being viewed.
3. File number: displays current file number.
4. Elapsed time: Displays the elapsed time for the video being watched.
5. Time: displays the start time that the current file was recorded.
6. Date: displays date that the current file was recorded.
7. Playback controls: use the Dash Cam buttons as described below.
8. Battery: indicates whether Dash Cam is running on battery or external power.
9. Protected file: indicates that the video file is protected.

Playback Controls:

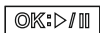

Press the OK button to play / pause playback.



Press the MODE button to stop playback.



Use the UP button to select the previous file, this is only available once playback has been stopped.

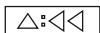

During playback press the UP button to rewind, press the DOWN button to cancel.



Use the DOWN button to select the next file, this is only available once playback has been stopped.



During playback press the DOWN button to fast forward, press the UP button to cancel.

Note:

- When playback is paused the UP and DOWN buttons can be used to move forwards / backwards a single frame at a time.

PLAYBACK MODE

Photo Files:

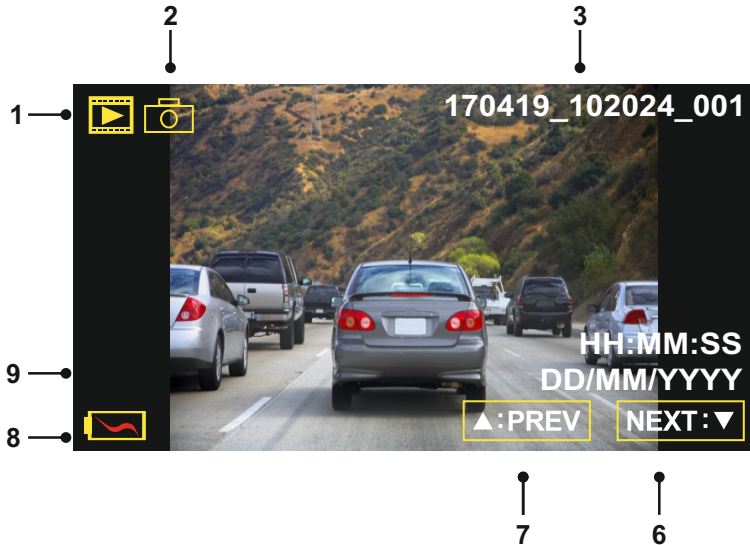

1. Mode: indicates the iN-CAR CAM is in Playback mode.
2. File type: indicates whether a video or photo file is being viewed.
3. File number: displays current file number.
4. Time: displays the time that the current image was taken.
5. Date: displays the date that the current image was taken.
6. Next: press the down button to move to previous file.
7. Previous: press the up button to move to previous file.
8. Battery: indicates whether iN-CAR CAM is running on battery or external power.
9. Protected file: indicates that the video file is protected.

Within Playback mode there are options available to Delete and Protect files, press the MENU button to access the Playback Menu.

See following pages for details.

PLAYBACK MODE (CONTD.)

Deleting files:

Highlight the Delete Files option and press the OK button.

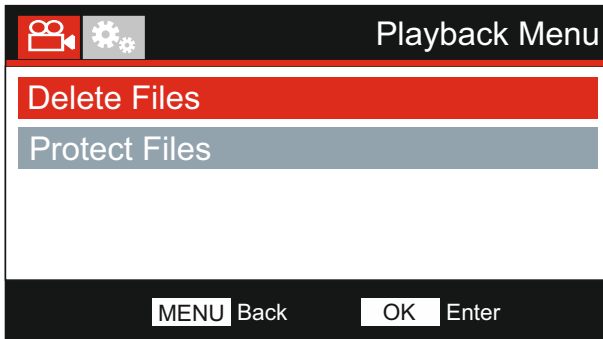

This will then give you two options:

Delete File

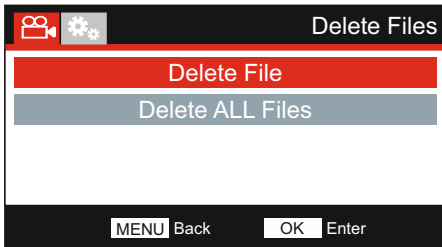

Once selected, follow the on screen instructions to delete the current file.

Delete ALL Files

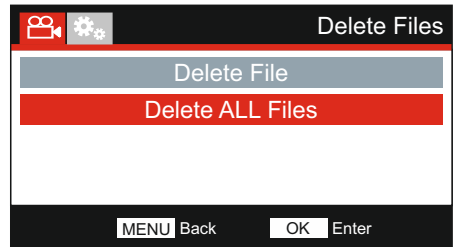

Once selected, follow the on screen instructions to delete all files.

Note:

- Protected files cannot be deleted.
- If files are deleted using this menu, then BOTH High resolution and Low resolution versions of the same file are deleted simultaneously.

PLAYBACK MODE (CONTD.)

Protecting files:

Highlight the Protect Files option and press the OK button.

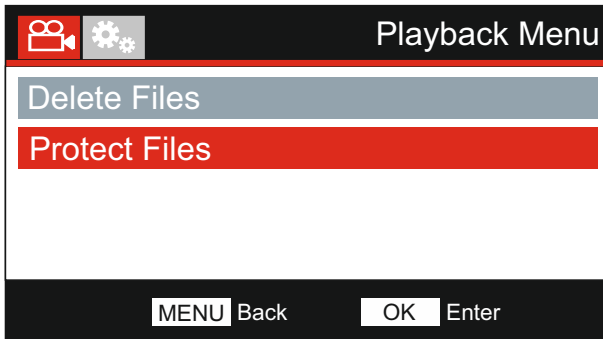

This will then give you two options:

Protect File

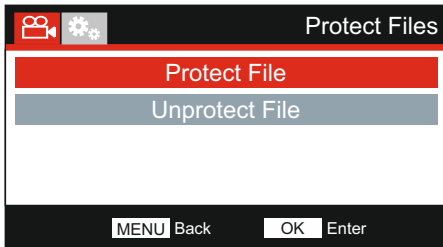

Once selected, follow the on screen instructions to Protect the current file

Unprotect File

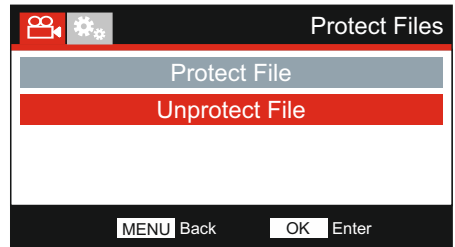

Once selected, follow the on screen instructions to Unprotect the current file.

Note:

- The 'Protect' button can also be used to Protect files when in Playback Mode.
- The 'Protect' button will protect BOTH High resolution and Low resolution video files simultaneously.

SETUP MENU

Setup Menu

The Setup Menu is accessed by pressing the MENU button twice.

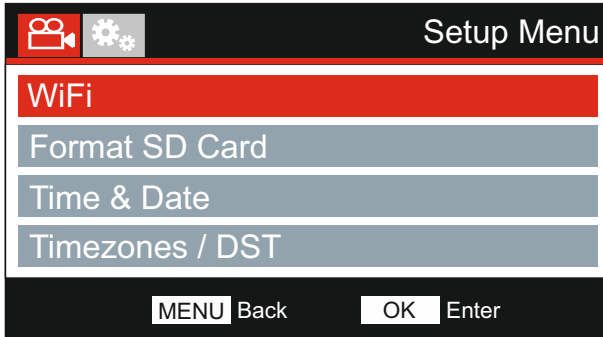

The default settings have been carefully selected to allow you to use the Dash Cam without the need to change any settings. However, should you wish to change a setting then please see below.

Use the up and down buttons to highlight the function that you'd like to change and press the OK button to enter the settings sub-menu.

Once in the sub-menu, use the up and down buttons to highlight the required setting and then press OK to confirm your selection and return to the Photo Menu.

Press the MENU button twice to return to video mode.

1. Wi-Fi

The Wi-Fi function allows you to use your smartphone or tablet device to view recordings directly from the Dash Cam.

2. Format SD Card

Format the inserted memory card, this will delete all content.

Note:

- For stable performance, it is recommended that you format the memory card every 2-3 weeks.

Of course, you should only do this AFTER you've downloaded any files from the card that you may want to keep.

3. Time & Date

Adjust the time / date as required using the OK button to toggle through the fields and use the up & down buttons to set variables. Press MENU to exit and return to the Setup Menu.

4. Time Zone / DST

The Time and Date are automatically set based on the Country selected from within the First Time Use menu.

The Time Zone / DST options are used should you want to manually select a Time Zone that falls outside of the available Country options.

SETUP MENU (CONTD.)

Continued from previous page.

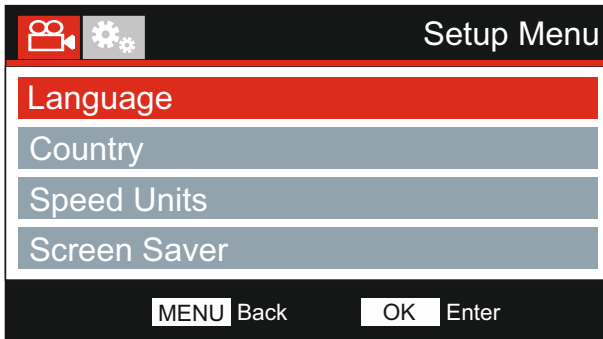

5. Language

Select preferred language.

Options: English, Danish, Dutch, Finnish, French, German, Italian, Norwegian
Spanish and Swedish

Default Setting: English

6. Country

Select your current Country, this will then automatically adjust the Time Zone / DST setting to your Time Zone, i.e. if France is selected the Time Zone will become GMT +1.

If your required Country is not available, select 'Other'. This will take you to the 'Time Zone / DST' menu, from there you can manually select your Time Zone.

Options: UK & Ireland, Belgium, Denmark, Finland, France, Germany, Italy, Netherlands,
Norway, Poland, Spain, Sweden, USA, Canada, Mexico and Other

Default Setting: UK & Ireland

7. Speed Units

Select whether to record and display speed in KMH or MPH.

Options: KMH and MPH

Default Setting: MPH

8. Screen Saver

Turn on the Screen Saver function to shut down the screen after 30 seconds of button inactivity, press any button to re-activate the display.

Options: On and Off

Default Setting: Off

SETUP MENU (CONTD.)

Continued from previous page.

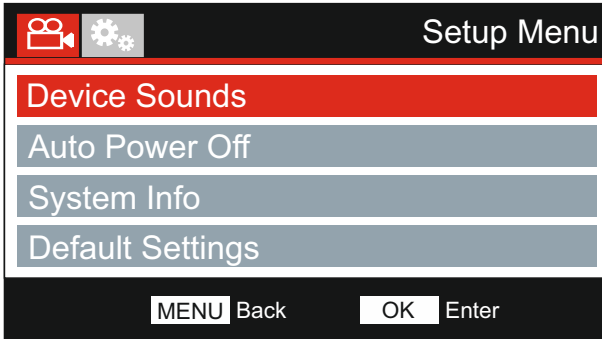

9. Device Sounds

Turn Off / On the beep sound which is heard when a button is pressed and also mute the startup and shutdown chimes.

Options: On and Off

Default Setting: On

10. Auto Power Off

Adjust the timing of the Auto Power Off function, this can be used to continue recording in event of loss of power within the vehicle.

Options: 10 Seconds, 1 Minute and 2 Minutes

Default Setting: 10 Seconds

11. System Info

This covers multiple screens (pages), press OK to scroll down as required.

The model number and installed Firmware version of your Dash Cam is displayed here.

FCC-ID is shown here under the E-Label Act (USA).

SD Card Information is provided for the installed SD card within the Dash Cam

Wi-Fi Information is provided for the Dash Cam. The SSID (network name), Password and MAC address.

12. Default Settings

Reset the Dash Cam to the default settings.

PC CONNECTION

Use the supplied USB cable to connect the Dash Cam directly to your PC via the  socket, do NOT connect the USB cable to the Powered Mount.

Once connected the Dash Cam will turn on with three options available, as described below.

- Mass Storage
- Power On
- Update

Use the UP and DOWN buttons to select required function and press OK to confirm selection.

Mass Storage (Windows)

When this option is selected, the Dash Cam will function as a card reader for your PC. An extra drive will appear, e.g. Removable Disk (D:) and you will be able to view / manage the stored files upon the MicroSD card within the Dash Cam.

Note:

- The Dash Cam is a 'read-only' device, therefore uploading files to the SD card when in Mass Storage mode is not possible.

Turn off the camera before disconnecting from your computer.

Mass Storage (Mac)

When this option is selected, the Dash Cam will function as a card reader for your MAC. The Dash Cam will be seen as an external disk upon your MAC and you will be able to view and/or manage stored files.

Note:

- The Dash Cam is a 'read-only' device, therefore uploading files to the SD card when in Mass Storage mode is not possible.

Turn off the camera before disconnecting from your computer.

Power On (Windows & Mac)

When this option is selected, the Dash Cam will power on with all functions available. This includes charging of the internal battery, a full charge will take approximately 2 hours.

Note:

- ALWAYS turn Off the Dash Cam before disconnecting from your computer.

Update (Windows and Mac)

When this option is selected, it is for use with the NEXTBASE Replay 3 Playback software in order to update the Firmware within the Dash Cam to the latest version.

Please see details within the NEXTBASE Replay 3 Playback software for more information.

TV CONNECTION

The iN-CAR CAM has two methods for video and audio output:

High Definition Output

When you connect a compatible High Definition cable (sold separately) between the iN-CAR CAM and your television, the iN-CAR CAM screen will blank. This is normal, as all output is now visible upon your television.

All playback functions of the iN-CAR CAM are available whilst using the High Definition output.

Standard Definition Output

When you connect a compatible Audio/Video cable (sold separately) between the iN-CAR CAM and your television, the iN-CAR CAM screen will blank. This is normal, as all output is now visible upon your television.

All playback functions of the iN-CAR CAM are available whilst using the Standard Definition output.

Please contact your local NEXTBASE dealer for accessory purchases.

Note:

- An external power supply may be required when viewing recordings via the AV or HD output of the iN-CAR CAM, e.g. using the supplied USB cable with a 5Vdc/USB adaptor, of the type typically supplied with mobile phones.
- ENSURE that any external power sources are of the correct 5Vdc output, otherwise damage will be caused that is not covered under the manufacturers warranty.
- Recording is not possible whilst using either the high or the standard Definition output.

Wi-Fi CONNECTION

The 412GW can share the files on the SD card with a mobile phone or tablet (minimum operating system requires Android 5.1 or above and iOS 10.3 or above) using the **Cam Viewer** App.

The App can be downloaded from the Google Play store (Android) or the Apple App store (iOS).

The Wi-Fi mode can be accessed when the camera has stopped recording by pressing the red exclamation mark button when in video mode, button 7 (page 13), for 3 seconds. Then go into the Wi-Fi settings on the mobile device and connect to the Dash Cams Wi-Fi signal. Once connected you can open the Cam Viewer App and begin viewing, downloading and sharing your recorded files.

TROUBLE SHOOTING

PROBLEM	SOLUTION
The sucker will not stay in place upon my windscreen.	Ensure that the protective cover (plastic film) has been removed from the suction pad. Moisten the sucker slightly before affixing upon the windscreen. Ensure that the locking lever is fully open when the sucker is pushed on to the windscreen and then close the lever. Make sure that the glass is smooth and clean. Do not stick to glass that has any non-smooth effect or paint whatsoever. Affix to the glass firmly and then close the locking lever fully.
I cannot insert the MicroSD card.	MicroSD card are very small and require delicate use. Align the card with the diagram shown upon the Dash Cam and insert the card until you feel a slight spring resistance. You now need to push the card, using your finger nail, until you hear and feel a small latch. Release pressure and the card will stay retained within the device. Use the edge of a small coin if you have difficulty.
I cannot remove the MicroSD card.	With the card previously installed, you now need to push the card further inwards slightly, using your finger nail, until you hear and feel a small latch. Use the edge of a small coin if you have difficulty. Release pressure and the card will spring out sufficiently for you to take hold of it.
I can only record a few minutes of video on my MicroSD card.	Change the recording size (Video Length function) to a smaller size. Increase the size of the MicroSD card. Max 128GB.
I cannot save files to the memory card when the Dash Cam is connected to my computer under Mass Storage mode.	Correct, the Dash Cam is a 'read-only' device. It is not recommended to save files from other sources to the same memory that you will use for recording within the Dash Cam, as these may have a negative effect on the performance of the Dash Cam.
No power to my Dash Cam, but it works upon my PC.	The cigarette power cable is not working. Inspect the fuse in the Car Power plug. Replacement fuse = 2A 20mm type. If the fuse is found to be blown, inspect the power cable for damage which may have caused the fuse blow.
My Dash Cam shuts down by itself after a while.	Either the battery has gone flat, there is no power to the Dash Cam and the Auto Power Off period has been triggered or Parking Mode has been turned on and no vehicle movement has been detected for 5 minutes.
The screen blanks after a few minutes upon my Dash Cam.	The screen saver is set to ON. Change settings to OFF if required. Default setting is off.
The battery will not charge.	Ensure the Dash Cam is connected to a reliable power source and that the supplied Car Power Cable is being used, with the Power LED lit.

TROUBLE SHOOTING (CONTD.)

PROBLEM	SOLUTION
The battery only last 30 seconds.	The battery will only receive charge when the Dash Cam is connected to power, please reconnect the car adaptor or domestic USB charger and leave the Dash Cam to charge. Charging takes approximately 90 minutes and a full charge is indicated when the BLUE (charging) LED goes out. Does the problem persist? If not... the car power supply may be causing the issue.
The battery only lasts 30 minutes.	This is normal, the battery design allows the 'Auto Power Off' feature to function in event of power loss within the vehicle. It is not intended as an alternative power source to replace the supplied car adaptor.
The Dash Cam cannot lock onto satellite.	After power on and with the device mounted with clear view of the sky it can take up to 10 minutes to find the three satellites required to achieve a stable signal. Reception can also be affected by atmospheric conditions and the proximity of buildings / trees obscuring the sky.
I get the message "SD Card Error. Please format SD card" on screen.	The SD card has been formatted in another device and the Cluster Size is not compatible or the SD card is formatted in ExFAT / NTFS. There may also be an error on the card. Use the Setup option to re-format the SD card from within the Dash Cam.
I get the message "Card Full" on screen.	The SD card has become full as there may be too many protected files which will not be deleted to allow for further recording to take place. Delete unnecessary files or perform a full FORMAT upon the SD card from within the Dash Cam Setup Menu.
The SD card in my Dash Cam cannot be read.	Use a good quality branded SD card between 8GB and 128GB (Class 10 or UHS type 1) and format the card from within the Setup Menu.
I can't delete files on my SD card within the Dash Cam.	Check to see if these files are 'protected', if so please follow instructions to 'un-protect'.
Mass Storage function does not work.	The Mass storage function will work on both Windows and Mac. Restart the PC, as this may be required for the necessary driver to be loaded correctly. Disconnect and reconnect the Dash Cam. Contact NEXTBASE for the required driver.
Video files cannot be played.	The video files from the iN CAR CAM are in .MOV format and may not be compatible with your PC if suitable playback software is not installed.
Video Image is blurred.	Remove the protective lens cover, clean the lens, adjust the polarising filter correctly, clean the windscreen!
My camera feels warm when it is operating.	It is normal for the camera to feel warm during typical use, especially while it is recording high definition video or communicating via Wi-Fi.

TROUBLE SHOOTING (CONTD.)

PROBLEM	SOLUTION
Video file playback is jumpy.	Remove the SD card and reformat to remove non-contiguous files. For best recording use a quality branded class 10 type (48MB/s) or UHS type 1 micro SD card of 8 to 128GB recommended size. PC may not be sufficient for the playback task, try a different PC. Copy the recorded video files onto the PC / Mac for playback directly rather than use the Dash Cam as a card reader, as the USB system on your PC may be too slow for HD video playback. Reduce the resolution of the recording within the Dash Cam and record some new files to test if this is the problem.
The sound is not synchronised with video during playback.	The Codecs upon your PC may not be compatible or the latest standard. Download the latest Codecs from: www.nextbase.com
Video has no sound.	Ensure that "Record Audio" setting is turned ON within the Video Menu of the Dash Cam.
Video playback is really quick on my PC, not consistent with the drive that was recorded.	Turn off the Time Lapse Recording, from within the Video Menu.
Photograph is blurred.	Hold the camera still whilst taking the photo. Please be aware the photo is taken around 1 second after the shutter noise is heard.
I have turned on 'Parking Mode' and now can't stop the recording.	The Dash Cam will start a recording whenever motion is detected. To turn off Parking Mode firstly shutdown the Dash Cam and remove the SD card, this will avoid recording being activated accidentally. Switch the Dash Cam On and within the Setup Menu, turn off the 'Parking Mode'.
When I get in to my car, the Dash Cam is already recording and the file is protected.	This is normal. Parking Mode has been switched on and the Dash Cam has sensed vibration and has started to record correctly. Parking mode can be turned off within the Video menu if required.
When I press the MENU button nothing happens.	This is normal during recording. Stop the recording before pressing the MENU button. If recording re-starts before you can press MENU, then see the Parking Mode section above.
The time on my Dash Cam is wrong and when I adjust the time manually, it keeps changing.	The Dash Cam sets the time based upon the country which has been selected and also whether Daylight Savings time is currently in force. Please verify the Country setting within the menu is correct. The Time Zone can be set manually, if the Dash Cam is to be used outside the listed countries in the Setup Menu.
Downloading files from www.nextbase.com using Google Chrome results in a Malicious Software message.	This is not a cause for concern, simply go to the settings within Google Chrome and turn off the malicious software protection temporarily to download and install the playback software. Reinstate previous Google Chrome settings thereafter.

TROUBLE SHOOTING (CONTD.)

PROBLEM	SOLUTION
My Mobile Device will not connect to my camera.	Please ensure that you have turned the Dash Cam Wi-Fi Mode on by either using the Wi-Fi button or through the Settings Menu. When Wi-Fi Mode is turned on the screen of the Dash Cam will display the Network Name and Password. This password is case sensitive.
The NEXTBASE Cam Viewer app will not open.	Please uninstall the NEXTBASE Cam Viewer app and re-download again from your devices App Store.
When I open the NEXTBASE Cam Viewer App I get a message saying 'Please Check Device'.	Ensure that the Dash Cam is in Wi-Fi Mode and that your mobile device has connected to the Dash Cam Wi-Fi connection.
When I try to play back a file from my Dash Cam I get a message saying 'Buffering' but the video does not load.	Please restart your mobile device and reconnect to the Dash Cam Wi-Fi connection. Then re-open the Cam Viewer App.
I am unable to playback a specific video file from the SD card when using my PC.	The file may have not been closed correctly during recording. Repair may be possible by re-inserting the SD card back in to the Dash Cam, select Playback Mode and playing the affected video file.
When looking at my SD card using a computer I see HI & LO files. Why is this ?	The HI file is High Resolution video file (as per the settings) and the LO file is LOW resolution video file which is used by the Wi-Fi APP to mobile devices, for efficient streaming / uploading etc.
On my SD card, I can only see files with the LO.MOV extension. Why is this ?	Previous viewing of the SD card has resulted in deleting only the High resolution HI.MOV video files, leaving the LO.MOV files remaining. Simply perform a format of the SD card from within the Dash Cam in order to delete all unnecessary video files.
I know that the Low resolution files are on the SD card, but why can't I see them in the Playback mode ?	Only the High resolution files are shown in Playback mode, but the duplicate Low resolution files are still there behind. The High resolution file is perfect to play upon the Dash Cam itself and also via the HD-OUT connector to your large screen TV.
Card full and card error message.	Is a branded card that is compatible with loop recording being used? This issue can occur if a counterfeit, slow or unbranded SD card is being used.
No mass storage option.	Try multiple USB ports and an alternative mini USB cable (if possible), please ensure it is inserted into the USB port on the Dash Cam and not into the mount.

TROUBLE SHOOTING (CONTD.)

PROBLEM	SOLUTION
Juddering image.	This is usually caused by a PC that is not compatible with HD or Ultra HD playback, we recommend an i5 or equivalent to play the files and metadata effectively.
Unresolved issues.	Reset the Dash Cam to the Default Settings within the Setup Menu and try again. Should the problem persist call the UK helpline (02920) 866429 or call your local support centre found at www.nextbase.com Alternatively email: support@nextbase.com

NEXTBASE

www.nextbase.com



NBDVR412GW-IM-ENG-R12